

JetHand Dryer-AK2030

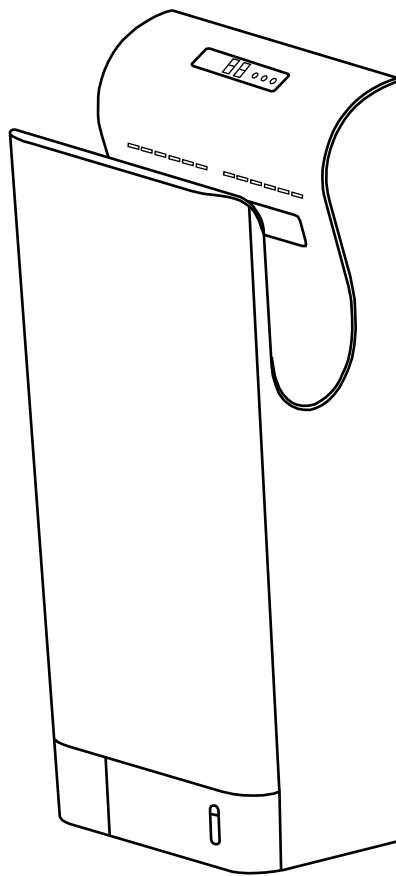

Features

- Dual sides jet air enable fast dry hands in 7-10s
- 24,000 RPM brushless motor, stable and eco, with lower noise, and up to 10 years life time
- HEPA Filter and UV light to kill bacteria in air flow on hands
- Removable drain tank, keep the ground clean
- Intelligent LED display drying time and error code
- Adjustable hidden switch allow to adjust high/low air speed and temperature

Customize your dryers' temperature:

1. Turn on the intelligent heat system. When the room temperature is higher than 25 °C, It blows normal temperature air (700W). When the room temperature is below 25 °C, It blows warm air (1850W)
2. Turn off the intelligent heat system. It blows normal temperature air (700W).
3. Turn on the intelligent heat system. Remove the temperature sensor(Explanation in the instructions), It always blows warm air (1850W).

Anti-damage timer

Installed anti-damage timer, this machine will stop work after working 25 seconds. Draw out your hands and put again your hands into the dryer to continue use.

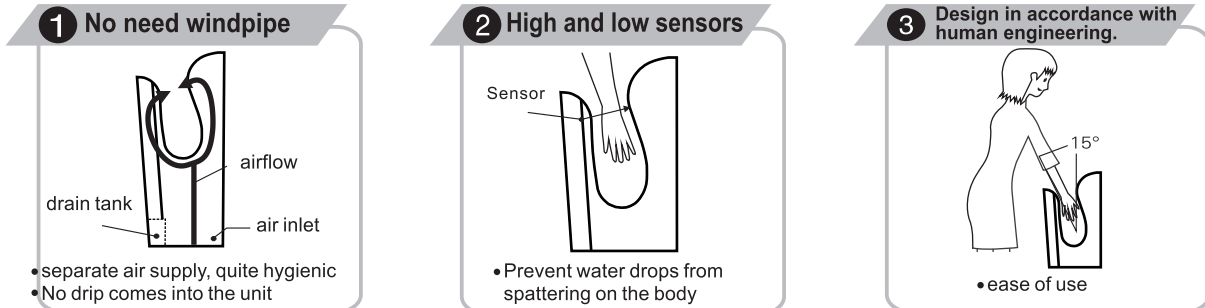

SPECIFICATIONS

ELECTRICAL

| VOLTS | WATTS | NO HEAT WATTS | HERTZ | MOTOR |
|-------------------|------------|---------------|----------|--------------------|
| 100-130V/220-240V | 1650-2050W | 650-850W | 50/60 Hz | Brushless DC Motor |

DIMENSIONS

Height 700mm(27.6") Width 300 mm(11.8") Depth 215mm(8.5")

ACTIVATION

Automatic Sensor Operated

MOUNTING

Surface Mounted

WEIGHT

9.5 kg (20.9lbs)

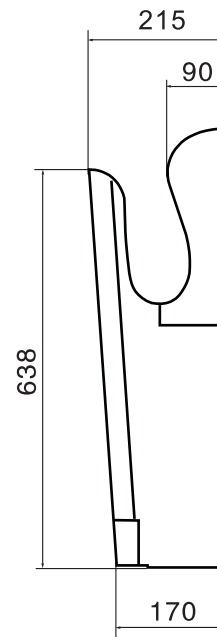
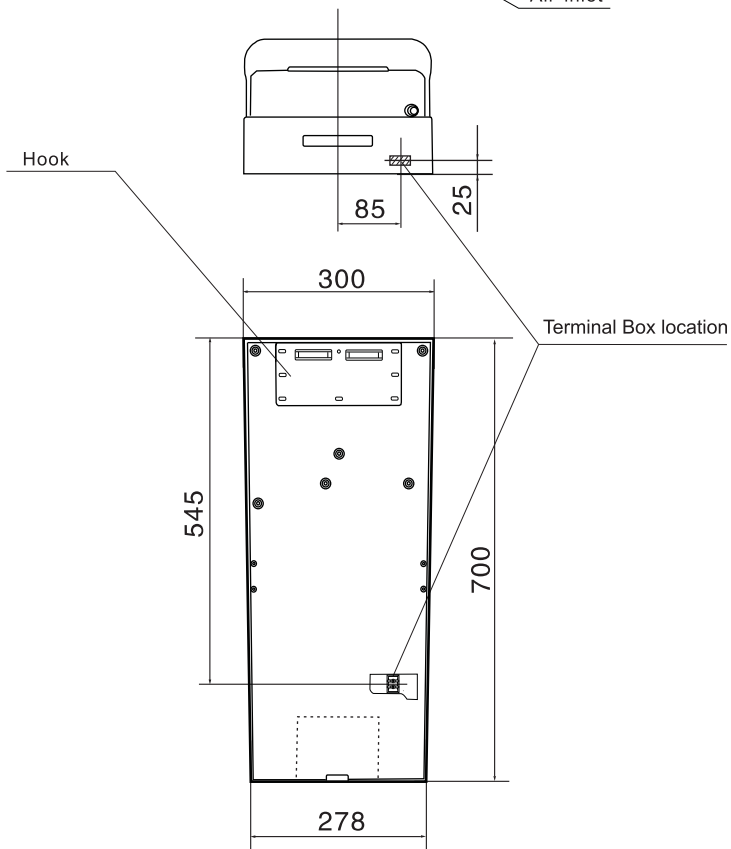
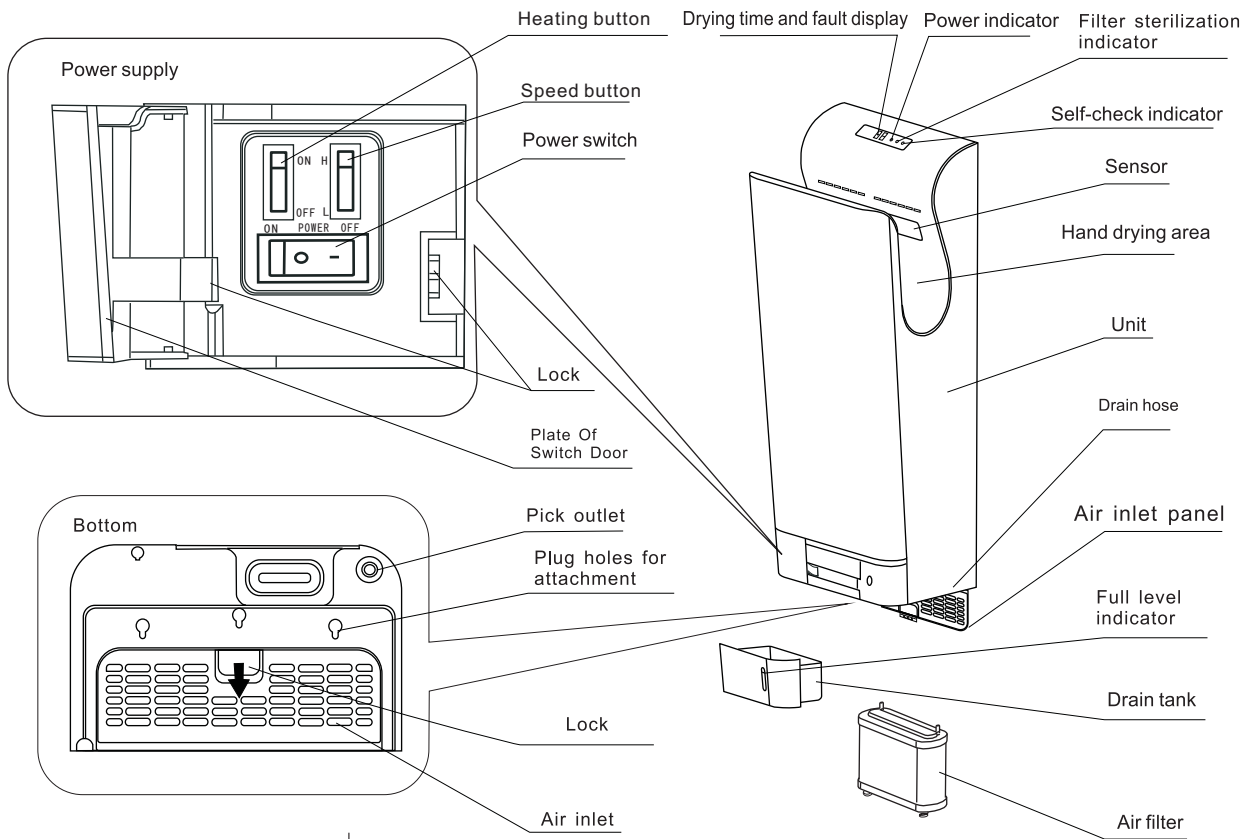

■ Using the Unit

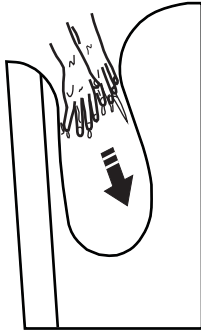

- Stretch out both hands and insert them all the way in. The unit starts to run automatically.

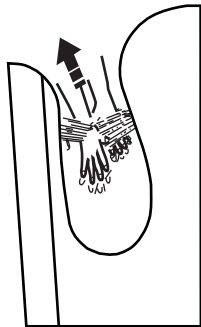

- Pull them out slowly, letting the air blow the water off.



- Pull them out completely.

Usage Label

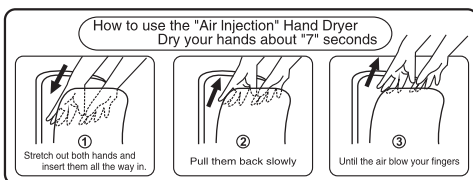

Stick the usage label on the visible place (the front of the unit or the wall nearby).

◆ When using the unit

Turn on the power switch.

- The lamp lights up.
- The air inlet panel is closed.

Routine Cleaning

Cleaning the Unit body Before it gets obviously dirty

- Clean the unit with a soft cloth.
If the unit gets very dirty, clean with a soft cloth dampened with neutral agent, then clean with a dry soft cloth.
- Remove the dirt from the sensor. (to prevent malfunction)



Note

- Only use the neutral cleaning agents.
- Do not use thinner, acidic or alkaline toilet cleaners, or nylon brush. (Otherwise, they may damage the smoothness of surface)
- Only use the alcohol to clean the hand-drying area. (Do not use alcohol anywhere else)
※Alcohol here means the alcohol used for disinfection (The concentration is 83% or below)
- If the chemical cloths used, please read their instructions first.
- Disinfecting agents will damage your unit.



WARNING



- Before you clean the unit, turn off the power switch.
- Do not splatter water on the unit



Caution

- Wear gloves when cleaning.
- The antibacterial coating is effective when the bacteria exposed the coated surfaces (See the shade areas on the figure)
- The antibacterial coating becomes not effective when the surfaces get very dirty.

Draining and Cleaning the drain tank Before it fills up (at least once a week)

- The water blown off the hands is called “drain water” .
- Empty the drain water at any moment, in order to prevent accumulated water from exceeding the full level.
- It will start smelling if the accumulated water remains in the tank for too long time.

1

1. Pull the drain tank out in the horizontal direction.
This ensures the drain water does not splatter out.

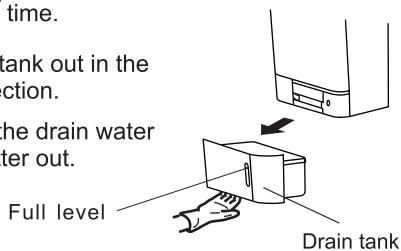

1

Remove the air filter

- Open the air inlet panel
Pull the air filter out by the handle.

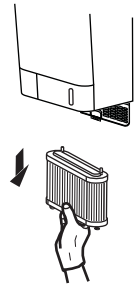

2

2. 1. Open the cover and empty the water.
• Pull the cover up with your fingers in the two corners of the cover, and then remove the cover completely.
2. Wash out the interior of the drain tank.
3. Close the water tank cover, and Re-attach it to the unit as original.

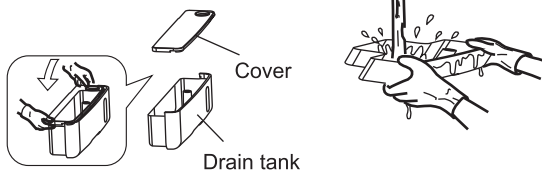

2

1. Cleaning the air filter

- Beat it lightly by hand or use a vacuum cleaner.
- It can also use hairbrush to wipe off dust.
- Air filter can directly to cleaned with water, Re-use after dry .

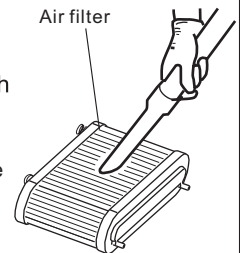

2. Re-attach to the unit.

- insert it all the way in, until it stops. (If it is not in place, the dirt or dust will enter the unit and shorten its service life.)

3

3. Add 200cc (around 1 cup) of water through the drain hole. (to prevent it from getting clogged)

- Use the unit after confirming that the water tank is in place.

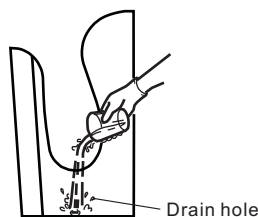

Trouble shooting、electrical schematic

If you discover the following circumstance, please inspection and handling as following:

| Problem | Check | Action |
|---|---|--|
| No air blows even if hands are inserted | Do the display indicators lights up? Is the power switch on? Are you putting your hands all the way in? | <ul style="list-style-type: none"> • Turn the ground-fault circuit breaker on. • Turn the power switch on. • Put hands all the way in . |
| Machine works long time after hands drawn out, finally shows E2 | <ul style="list-style-type: none"> • Any dirt or foreign body on sensor? | <ul style="list-style-type: none"> • Switch off the power button, and then remove dirt or foreign body on sensor after the power light gone out. When finished, switch on power button. |
| No hot wind | <ul style="list-style-type: none"> • There is a Built-in heater in the unit. Any dirt on heating sensor? • Checking if the internal heating fuse is burned? | <ul style="list-style-type: none"> • Is the ambient temperature higher than 25°C? • Turn off the power switch,removing the front panel and you will see a fuse holder inside . Unscrew the fuse holder and check if the fuse is burnt. |
| Airflow is too low | <ul style="list-style-type: none"> • Is the speed button on low level? | <ul style="list-style-type: none"> • Put speed button on the high level. |

If the above actions do not work, turn off the power and the ground-fault circuit breaker, and call your dealer to inspect and repair it if necessary. (Costs are as per agreement with the dealer)

Electrical schematic

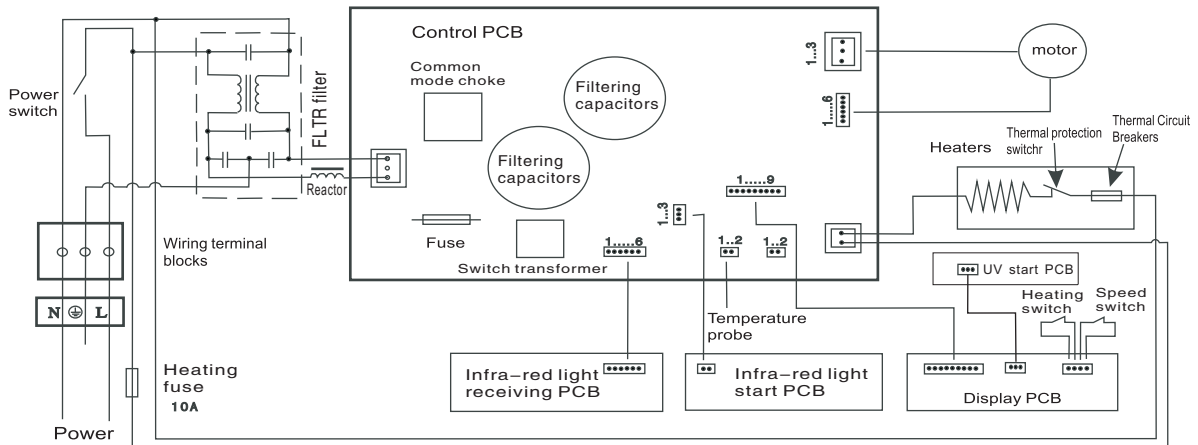

| | Status | Introductions | Status | Introductions | Solution |
|-------------------------------|-----------------|---|----------------|--|---|
| Power indicator light | Light | Power input normally | Extinguish | Power not supply | Check the external power source, close the power switch |
| | | | | Master board fuse blew out | |
| State indicator light | Extinguish | Don't work | Flashing light | Motor fault, it can't start normally | Check motor connecting wires and the rotor foreign material |
| | always light | Working | | Trick or working time longer than 25s | |
| Sterilization indicator light | Light | UV Emission plate disinfect sterilization start work after machine power on (one hour), thereafter once a day | Extinguish | Sterilization work has ended | Turn off the power, re-power After LEDs are off, Sterilization indicator is still not lit. Please check the UV Emission plat. |
| | | | | UV Emission plate error | |
| Timing digital tube | Digital changes | Countdown work | Jump display | Indicate drying time finished | |
| | E1 | Motor fault, it can't start normally | E2 | Trick or working time longer than 25 seconds | Clear workspace foreign material, restart to work |
| | E3 | The voltage exceeds 15% | E4 | The voltage lower than 15% | Check the power supply circuit |
| | E5 | Machine temperatures higher than 80°C | E6 | Master board temperatures higher than 80°C | Clear the foreign material of the air inlet and air outlet |
| | | | | E8 | Fan fault |



WARNING personal injury accidents will happen if use improperly



Prohibited



Do not use in the bathtub or shower room



Do not allow The unit get wet



Prohibit disassembling



Please do complying with instruction



Ground



WARNING

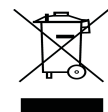

- Do not open the front panel . otherwise, This may get an electric shock
- Children forbidden hanging on the machine, there are risk of falling.
- Do not use in a wet environment,for example,near the bathroom where it may get the direct water and the places where the condensation may form.otherwise,this may cause electric shock and unit malfunction.
- Do not allow the unit get wet.otherwise, it will cause electric shock
- Do not modify and disassemble the unit unnecessarily. Otherwise,this may cause a fire,electric shock,or personal injury.
- Rated power is required.
- If power tolerance is over +/-10%, there will be breakdown If using incorrect power supply, fire, electric shock and machine malfunction will happen.
- Please use dedicated socket If using together with other appliances, the socket may cause abnormal heat leading to fire.
- Power must be cut off when maintenance to prevent the risk of electric shock.
- Drain tank and air filter must be installed. Do not switch on after power connected for 10 seconds.
- If the machine doesn't work or have abnormal conditions, please cut off power to prevent accidents; and close leakage circuit breaker and ask supplier to check and repair, or it may lead to fire because of electricity leakage and short circuit
- It must have the reliable grounding wire otherwise it may cause electric shock risk when the unit failure or leakage
- Attention when installation: Do not install when the machine are power connected.
- It must operated by the professional construction person when install the unit If the construction incorrect, it may cause electric shock and fire accident
- This appliance is not intended for use by persons (including children) with reduced physical, sensory or mental capabilities, or lack of experience and knowledge, unless they have been given supervision or instruction concerning use of the appliance by a person responsible for their safety. If the cord is damaged, it must be replaced by the manufacturer, its service agent or similarly qualified persons in order to avoid a hazard. For additional protection, the installation of a residual current device (RCD) having a rated residual operating current not exceeding 30mA is advisable in the electrical circuit supplying the bathroom. ask your installer for advice.
- Please make sure the unit is equipped with HEPA during use, otherwise it will influence the service life of motor and main control board.
- **Environmental Protection** Waste electrical products should not be disposed of with household waste. Please recycle where facilities exist. Check with your Local Authority or retailer for recycling advice.

