

Mini Hand Dryer AK2805 Series

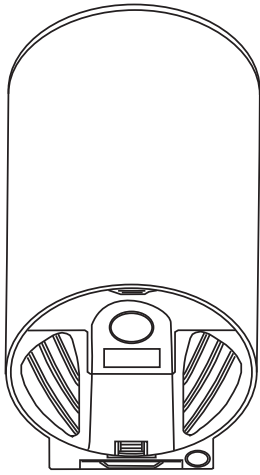

AK2805

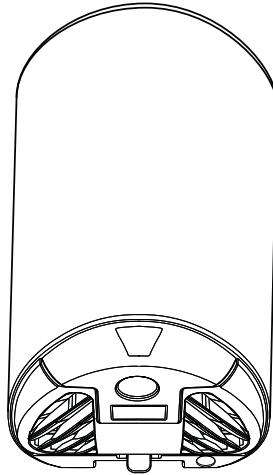

AK2806

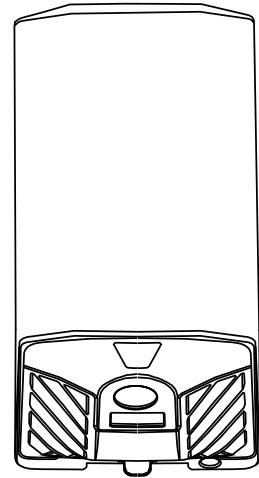

AK2807



Feature

- Innovative mini design,Smaller than A4 paper, save space
- Colorful 304 stainless steel shell, multiple choices
- Metal housing, durable and environmentally friendly
- Compact size, strong airflow and low noise
- Dynamic display of power indicator
- Plug in or concealed wire installation available

Customize your dryers' temperature:

1. When the room temperature is higher than 25°C, It blows normal temperature air (500W). When the room temperature is below 25°C, It blows warm air (1150W)
2. Remove the temperature sensor(Explanation in the instructions), It always blows warm air (1150W).

Specification

Model	AK2805	AK2806	AK2807
Dimension	280x153x162mm	280x170x170mm	280x153x162mm
N.W	3.4kg	3.4kg	3.5kg

Voltage	AC100-130V/220-240V	Motor	Brush motor
Phase	Single-phase	Sensing distance	15-20cm
Input	1150-1350W	Protection class	IPX1
Heating power	650-750W	Wind speed	68m/s

Name of each part

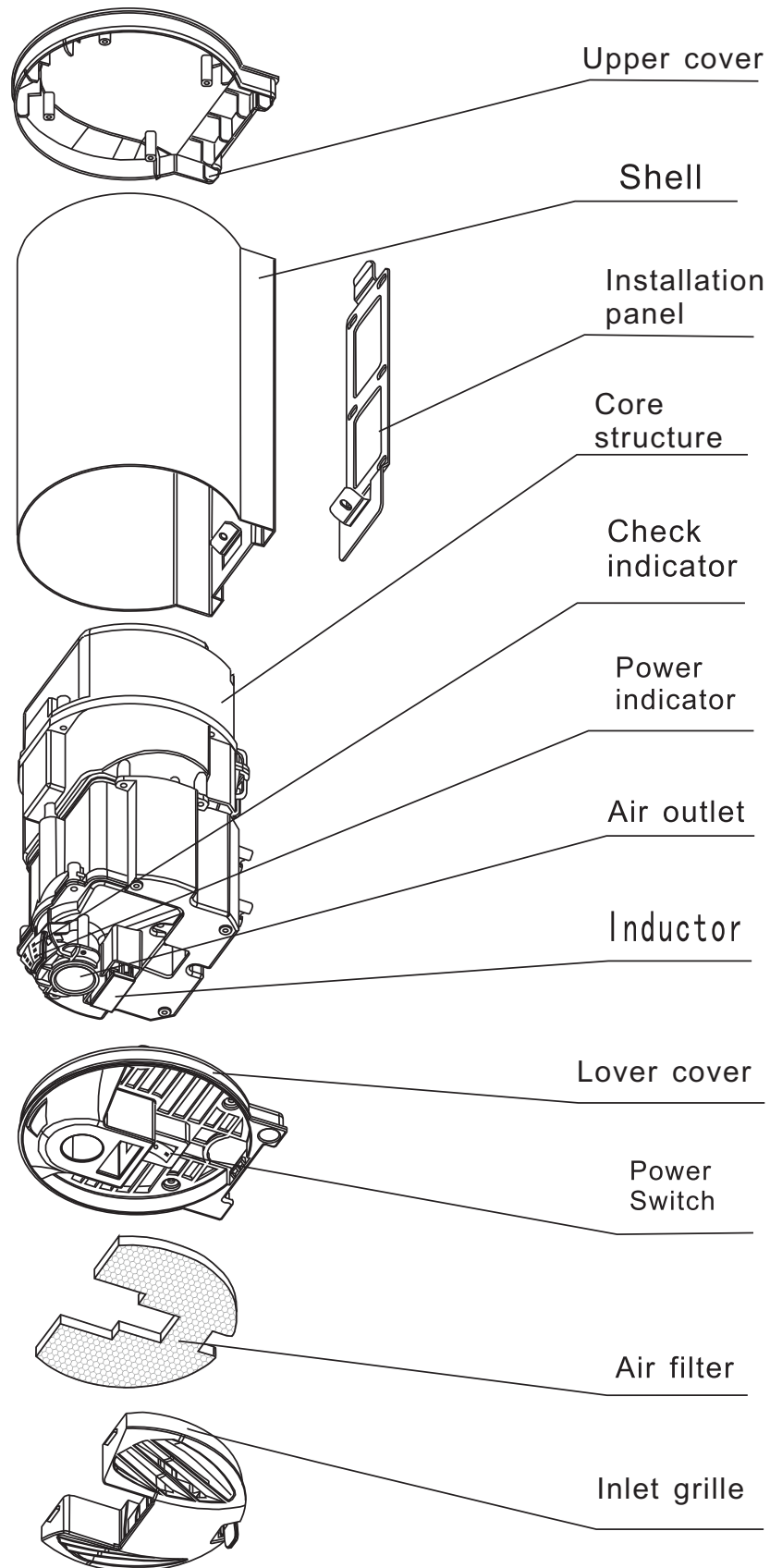

Electrical diagram

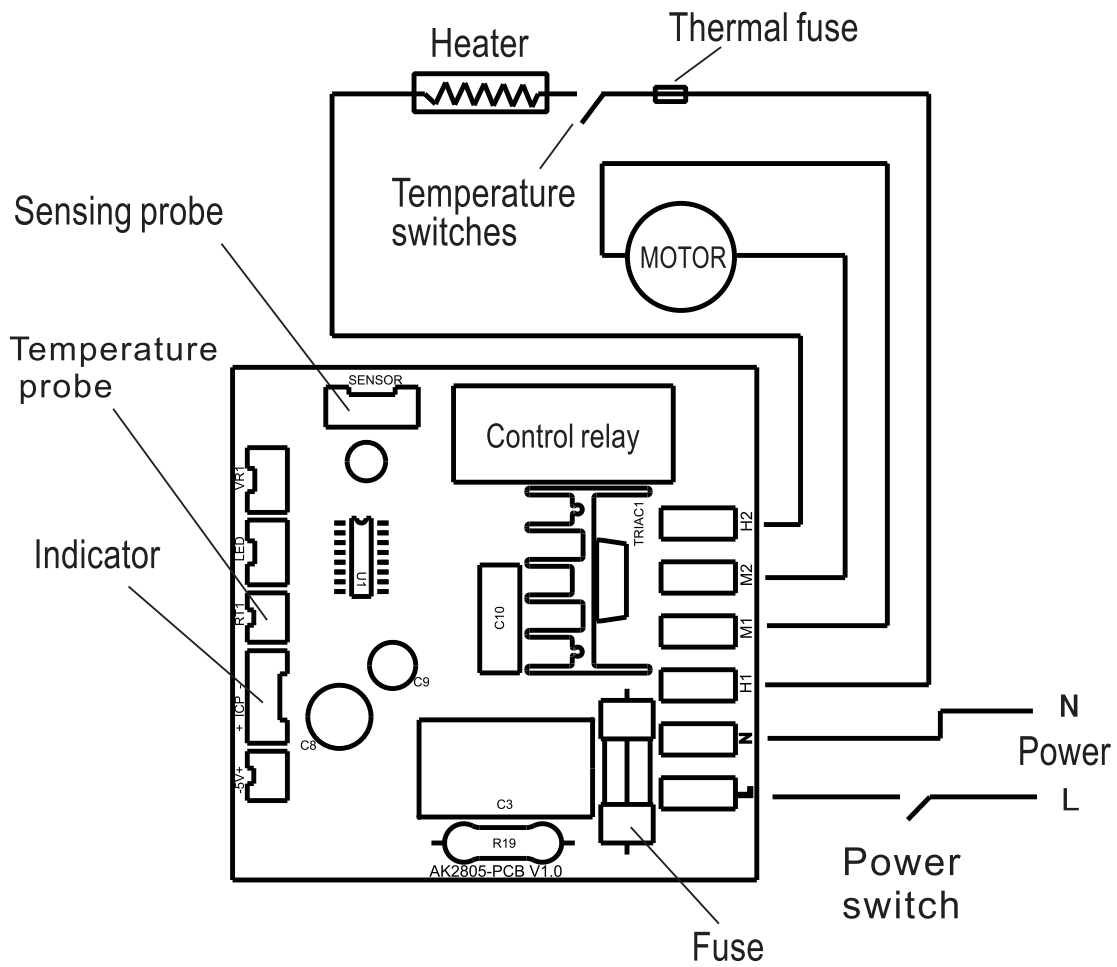

Daily use and maintenance

External maintenance

- Screw with a soft dry cloth or towel Sassafra. Please use neutral detergent Please don't use organic solvents, acid or alkali toilet cleaner, cleaning brush etc.
- ❗ Otherwise, the machine will destroy machine surface finish or produce discoloration.
- ❗ If using a chemical cloth, make sure that the use of attention.

1

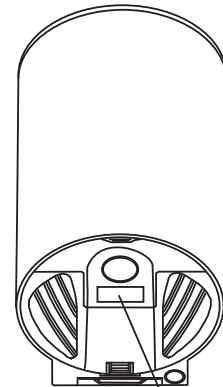

Sensing device

2

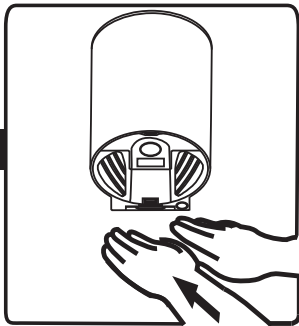

Slowly moving up the back of the hand before and after

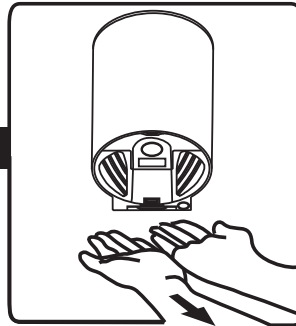

Palm of the hand before and after slowly moving upwards

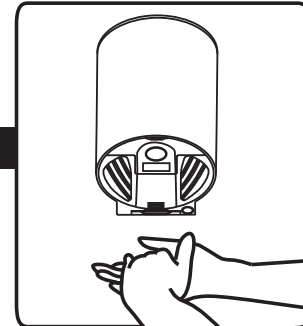

Mutual hands